

ARTÉS 900 PENDANT

INSTALLATION INSTRUCTIONS

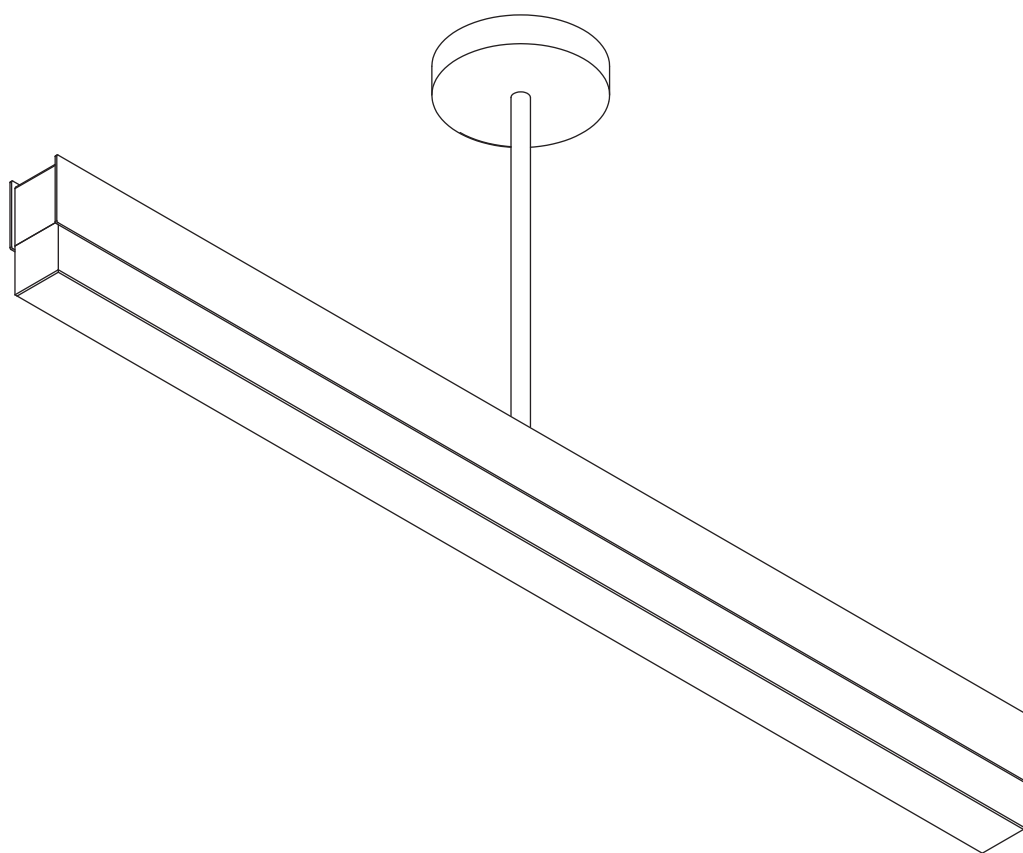

Please handle with care and wear gloves at all times during installation to avoid damaging or marking components.

BEFORE INSTALLATION

- Installation **must** be carried out by a qualified electrician.
- A minimum of **two** people are required to install this pendant.
- Check that the ceiling and fixing components are suitable and strong enough to support the weight of the pendant.
- Always wear soft cotton gloves during installation.
- Carefully unwrap the product and handle with care during installation.

PLEASE NOTE

The pendant cannot be rotated once mounted to the ceiling.

Ensure that it is installed in the desired position.

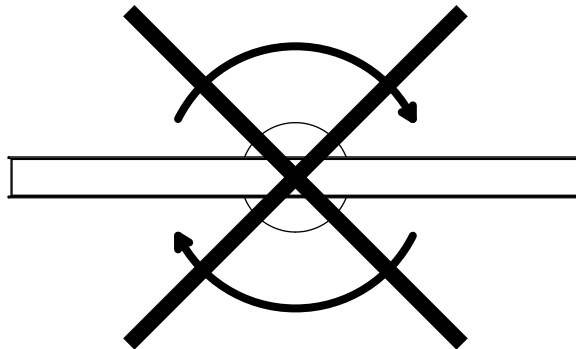

TECHNICAL

finish	bronze with satin brass details and honed alabaster satin brass drop rod and ceiling box CTO-01-042-0101
	satin brass with honed alabaster satin brass drop rod and ceiling box CTO-01-042-0102
bulbs	integrated LED - dimmable - 2700k - 24w
weight	8kg (18lbs)
cleaning	bronze and satin brass metalwork use a soft dry cloth to clean. If any marks remain clean the area using a damp soft cloth and dry afterwards with a soft cloth
	honed alabaster use a soft dry cloth to clean. If any marks remain clean the area using a damp soft cloth and dry afterwards with a soft cloth
replacement/ repairs	please contact CTO Lighting
warranty	CTO Lighting warranty, 1 year from date of delivery
certification	CE

COMPONENTS

A - Artés 900 Pendant

B - Drop rod and ceiling box

C - Ceiling mounting plate

D - 4 x Brass pan head screws

E - 4 x Steel countersunk screws

Please Note:

some parts are supplied assembled,
disassemble prior to installation.

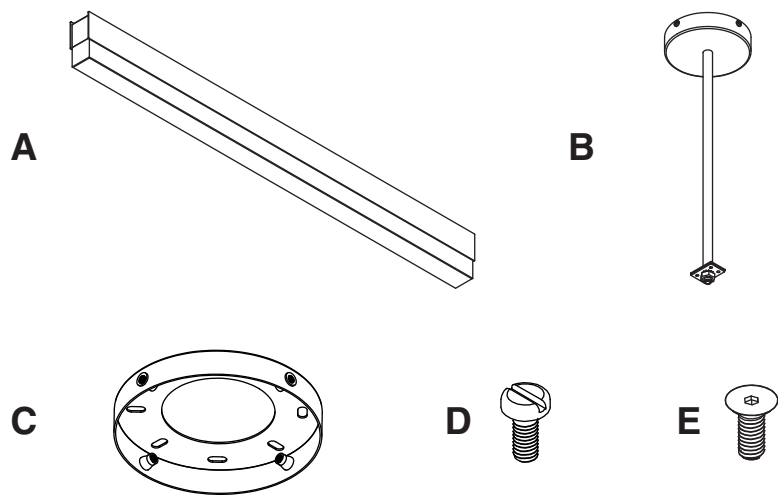

INSTALLATION

1. Thread the cable from the Artés Pendant through the drop rod and fix the two together using the 4 x steel countersunk screws until they are fully secure.

Lower the brass masking plate to hide the screw fittings.

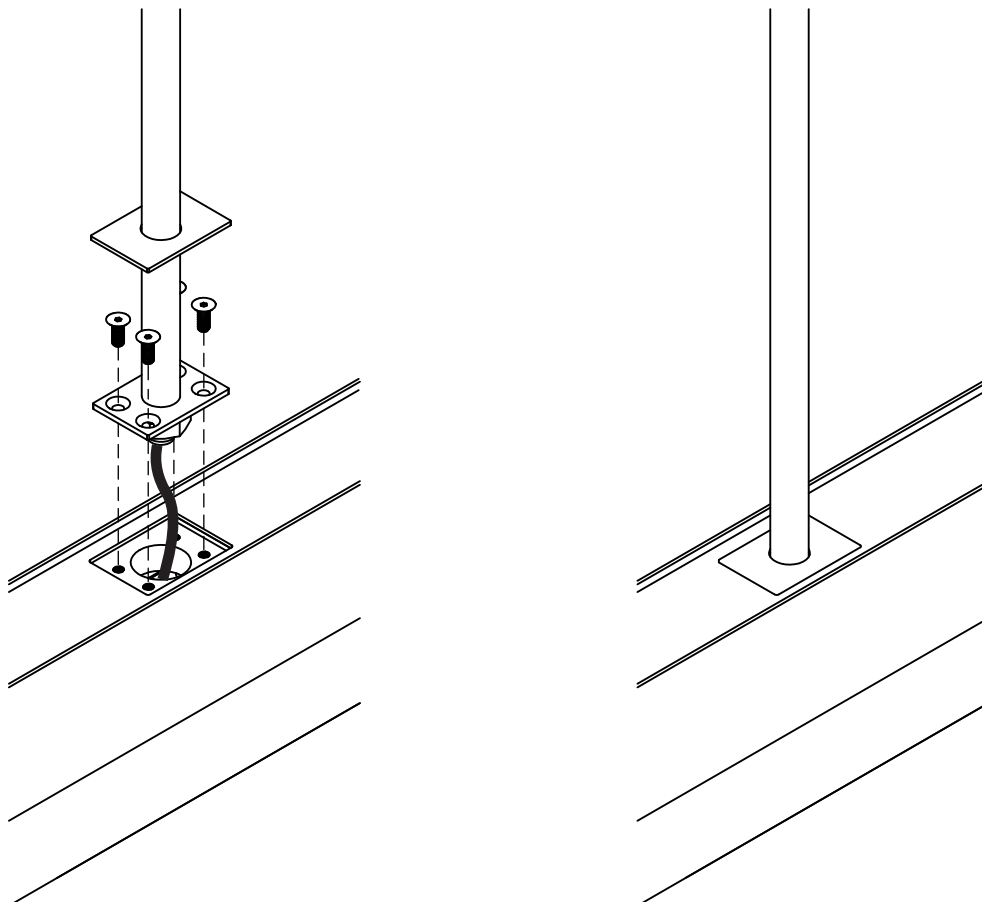

- 2.** Securely fix the mounting plate to the ceiling in the correct position using fixings suitable for the surface you are mounting to (not supplied).

Raise the pendant and make the electrical connections inside the ceiling box ensuring all wires are colour matched and the pendant is earthed correctly.

Bring the ceiling box cover up to the mounted plate and secure with the 4 x Brass pan head screws.

