

ARTES 600 WALL / CEILING IP44

FINISH

antique bronze with antique bronze details and honed alabaster
 bronze with bronze details and honed alabaster
 bronze with satin brass details and honed alabaster
 satin brass with satin brass details and honed alabaster

DIMENSIONS (body of fixture)

45 x 90 x 610 mm (w x d x h)

WEIGHT

4kg (8.8lbs)

please ensure wall/ceiling structure is strong enough to support the weight of the light

ILLUMINATION

220-240v - integrated LED - 16w - 2700k
 our bathroom lights are IP44 rated for 220-240v only
 the lights are not damp rated for 110-130v
 LED driver to be installed in the wall/ceiling cavity
 drivers must be installed up to 20 meters from the body of the light

DIMMING

trailing edge dimmable / phase cut (rotary dimmer) - standard
 DALI option available (220-240v only) - on request
 0/1-10v (220-240v) - on request

WALL ROSE / PLATE

rectangular wall box - 610 x 45 mm (w x d)

CERTIFICATION



VIEW ON WEBSITE

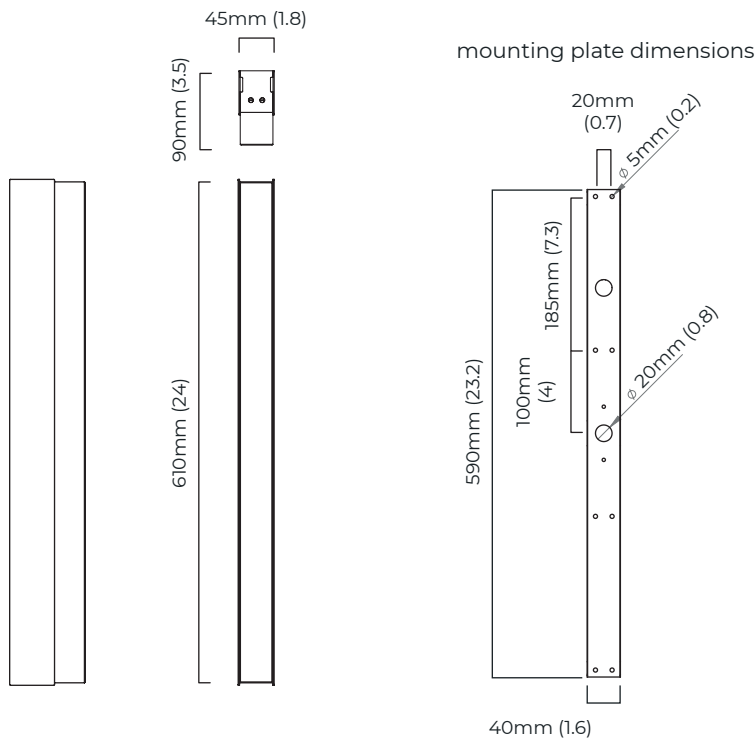

Remote LED Driver Dimensions

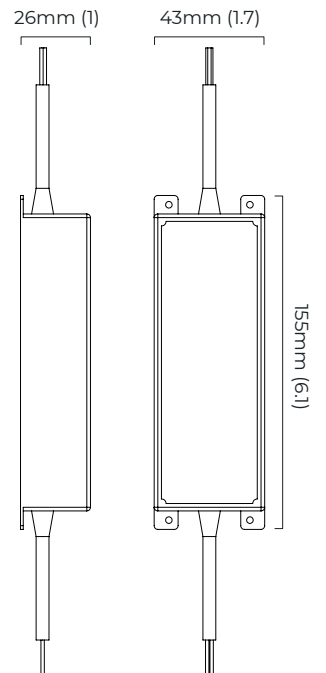

*Diagrams are not to scale.

ARTES 600 WALL / CEILING IP44

SKU NUMBER	FINISH DESCRIPTION	VOLTAGE
ARTCW6ABABHA44-240	antique bronze with antique bronze details and honed alabaster	220 - 240V
ARTCW6BZBZHA44-240	bronze with bronze details and honed alabaster	220 - 240V
ARTCW6BZSBHA44-240	bronze with satin brass details and honed alabaster	220 - 240V
ARTCW6SBSBHA44-240	satin brass with satin brass details and honed alabaster	220 - 240V

ARTES 600 WALL / CEILING IP44



The following information is a guide to help you understand what fittings can be placed in a bathroom. This is not an installation guide and reference should be made to the IEE Wiring Regulations (17th Edition) or a qualified electrician.

IP rating stands for “Ingress Protection” and is always followed by two characters. These two numbers refer to the level of protection and it is important that you choose fittings with the correct rating according to where they are to be sited within the bathroom.

When an electrical product is IP44 rated means that it is protected against small objects and water splashing from all directions. In case of lighting fixtures, they are designed for use in bathrooms and other environments where water spray is a risk factor.

The diagram above shows a bathroom split into four clear zones: 0, 1, 2 and 3.

ZONE 0	Is inside the bath or shower area itself. Any fitting used in this zone must be low voltage, (max 12v) and be rated at least IP67 which is total immersion proof.
ZONE 1	Is the area above the bath to a height of 2205 mm from the floor. In this zone a minimum rating of IP44 is required. If the fitting is 240v a 30ma residual current device (RCD) must also be used to protect the circuit in this zone.
ZONE 2	Is an area stretching 600 mm outside the perimeter of the bath and to a height of 3000 mm from the floor. In this zone IP rating of at least IP44 is required. In addition, the area around a wash basin within a 600 mm radius of any tap or water source to be considered as zone 2. In this zone IP rating of at least IP44 is required.
ZONE 3	Is anywhere outside zones 0, 1 and 2 and where no water jet is likely to be used. No IP rating is required. If there is a likelihood of water jets being used for cleaning purpose in zones 1,2 and 3 a fitting rated a minimum of IP65 must be used.

Regarding ceiling lights, when the room's height is less than 3000 mm, then Zone 2 is extended above the surface of the bath or shower base and a minimum of an IP44 light is required.

Full details can be found in the latest copy of the IEE wiring regulations.

IP44 rated wall lights are suitable for use in zones 2 and 3.